

99118

Dimensions

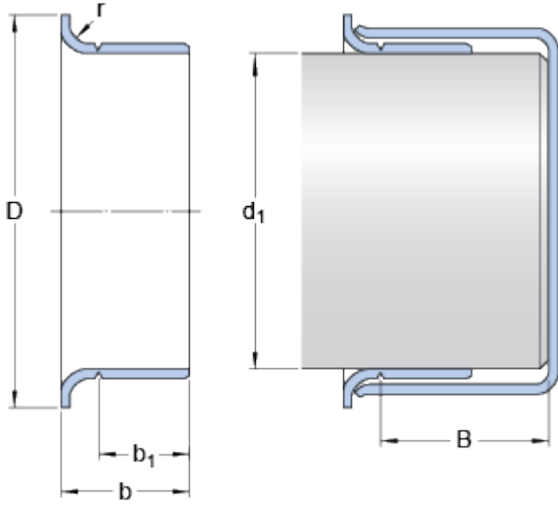

Shaft diameter range

d_1	min.	1.185	in
d_1	max.	1.19	in

Nominal dimensions

d_1		1.188	in
D		1.4	in
	\pm	0.063	in
b		0.438	in
	\pm	0.0315	in
b_1		0.313	in
	\pm	0.0315	in
B	max.	0.688	in
r	max.	0.125	in